

High Reliability Photo Coupler

K1010

UL 1577 (File No.E169586) VDE 0884 / 0860 / 0805 (File No.101347)

Features

1. Current transfer ratio
(CTR:MIN.50% at $I_F=5mA$ $V_{ce}=5V$)
2. High isolation voltage between input and output
(Viso:5000Vrms).
3. Compact dual-in-line package.
4. Available package : DIP/ SMD/ H.

Applications

1. Registers, copiers, automatic vending machines.
2. System appliances, measuring instruments.
3. Computer terminals, programmable controllers.
4. Communications, telephone, etc.
5. Electric home appliances, such as oil fan heaters, Microwave oven, Washer, Refrigerator, Air conditioner, etc.
6. Medical instruments, physical and chemical equipment.
7. Signal transmission between circuits of different potentials and impedances.
8. Facsimile equipment, Audio, Video.
9. Switching power supply, Laser beam printer.

Outside Dimension : Unit (mm)

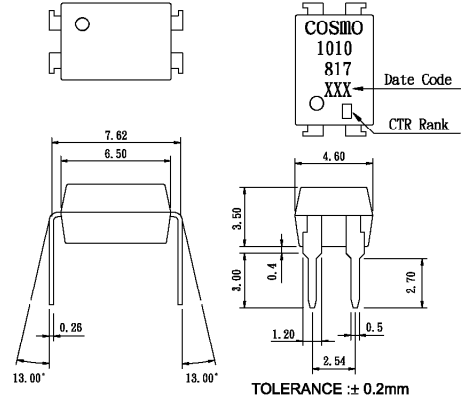

Schematic : Top View

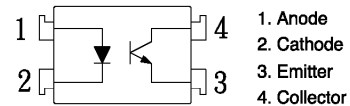

Absolute Maximum Ratings

(Ta=25°C)

Parameter	Symbol	Rating	Unit
Input	Forward current	50	mA
	Peak forward current	1	A
	Reverse voltage	6	V
	Power dissipation	70	mW
Output	Collector-emitter voltage	60	V
	Emitter-collector voltage	6	V
	Collector current	50	mA
	Collector power dissipation	150	mW
Total power dissipation	Ptot	200	mW
Isolation voltage 1 minute	Viso	5000	Vrms
Operating temperature	Topr	-30 to +100	°C
Storage temperature	Tstg	-55 to +125	°C
Soldering temperature 10 second	Tsol	260	°C

Electro-optical Characteristics

(Ta=25°C)

Parameter	Symbol	Conditions	MIN.	TYP.	MAX.	Unit
Input	Forward voltage	$I_F=20mA$	—	1.2	1.4	V
	Peak forward voltage	$I_{FM}=0.5A$	—	—	3.0	V
	Reverse current	$V_R=4V$	—	—	10	uA
	Terminal capacitance	$V=0, f=1kHz$	—	30	—	pF
Output	Collector dark current	$V_{CE}=20V$	—	—	0.1	uA
Transfer characteristics	Current transfer ratio	$I_F=5mA, V_{CE}=5V$	50	—	600	%
	Collector-emitter saturation voltage	$I_F=20mA, I_C=1mA$	—	0.1	0.2	V
	Isolation resistance	DC500V	5×10^{10}	10^{11}	—	ohm
	Floating capacitance	$V=0, f=1MHz$	—	0.6	1.0	pF
	Cut-off frequency	$V_{CC}=5V, I_C=2mA, R_L=100ohm$	—	80	—	kHz
	Response time(Rise)	$V_{CE}=2V, I_C=2mA, R_L=100ohm$	—	4	18	us
	Response time(Fall)		—	3	18	us

Classification table of current transfer ratio is shown below.

Model NO.	CTR (%)
A	80 TO 160
B	130 TO 260
C	200 TO 400
D	300 TO 600
E	50 TO 600

Fig.1 Current Transfer Ratio vs. Forward Current

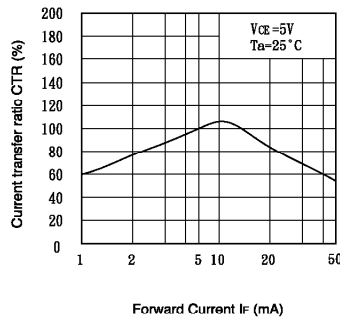

Fig.2 Collector Power Dissipation vs. Ambient Temperature

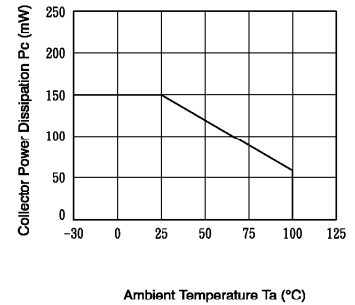

Fig.3 Collector Dark Current vs. Ambient Temperature

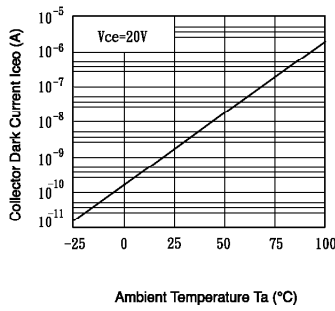

Fig.4 Forward Current vs. Ambient Temperature

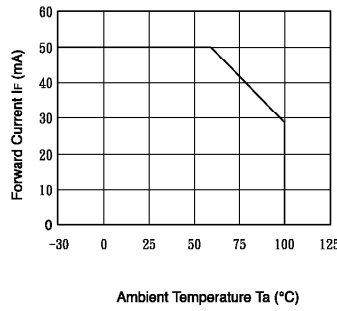

Fig.5 Forward Current vs. Forward Voltage

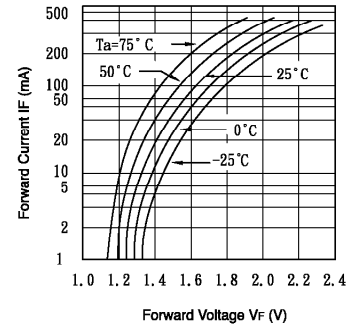

Fig.6 Collector Current vs. Collector-emitter Voltage

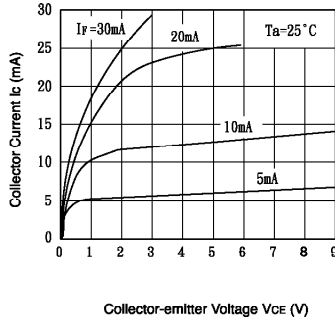

Fig.7 Relative Current Transfer Ratio vs. Ambient Temperature

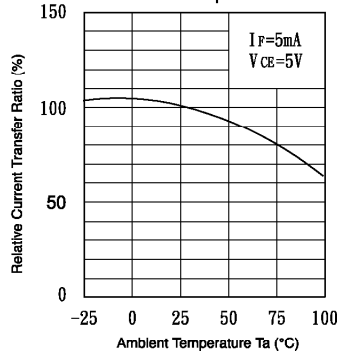

Fig.8 Collector-emitter Saturation Voltage vs. Ambient Temperature

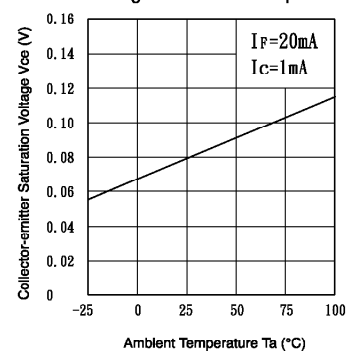

Fig.9 Collector-emitter Saturation Voltage vs. Forward Current

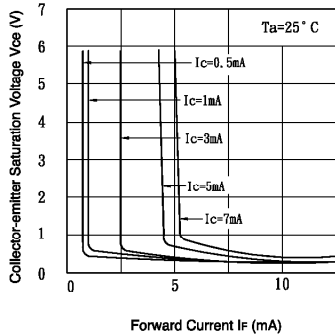

Fig.10 Response Time vs. Load Resistance

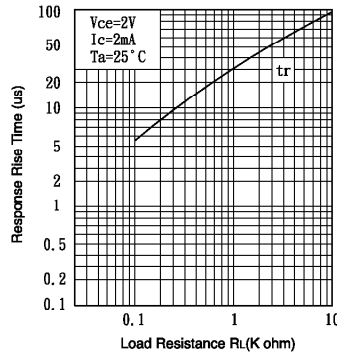

Fig.11 Response Time vs. Load Resistance

